

# Global Collection Floor Tile Trims

unglazed  
porcelain tiles

**Product description** Unglazed, porcelain floor tile trims, manufactured in accordance with EN 14411 Bla and ASTM standards. Mosa Ultragres floor tile trims are modular with a 3/16" joint and match Global Collection tiles in color and size.

**Sizes** See applicable technical drawings.

**Usage area** Our frost proof floor tile trims may be used in residential and commercial environments.

**Our limited warranty** Royal Mosa warrants that its first choice ceramic tiles are manufactured to ANSI-Standards A 137.1 and meet or exceed the requirements of the standard. Please consult the company's Terms and Conditions for Sale for complete product warranty details.

**Maintenance** Please consult our Cleaning and Maintenance leaflet.

## Accessories

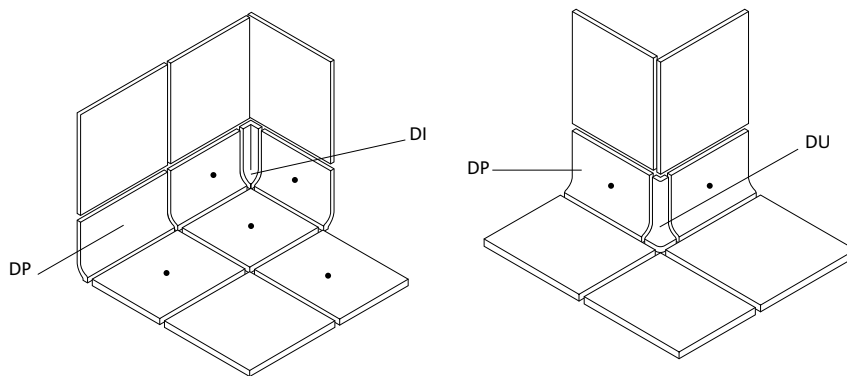

• = gerimeter-cut

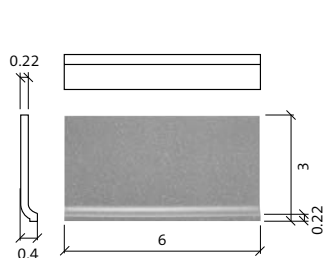

**DP** 3" x 6"  
thin cove base

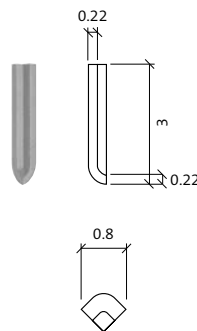

**DI** 3" x 0.8"  
inside angle

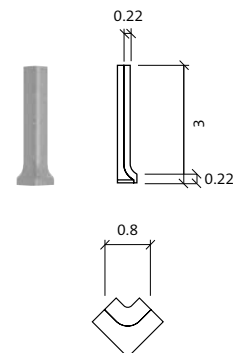

**DU** 3" x 0.8"  
outside angle

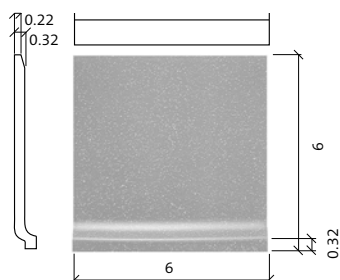

**SP** 6" x 6" x 0.32"/0.22"  
cove base

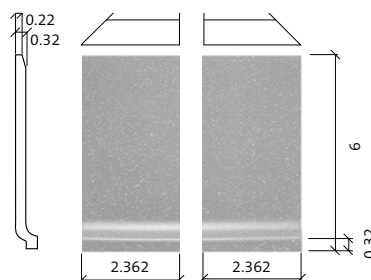

**LP** 6" x 2.362" **RP** 6" x 2.362"  
corner cove corner cove

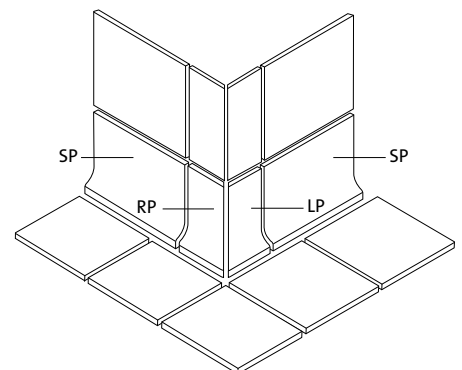

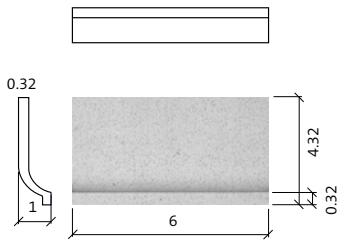

**P 4" x 6"**  
cove base

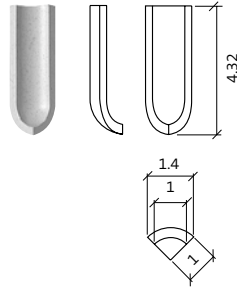

**I 4" x 1.4"**  
inside angle

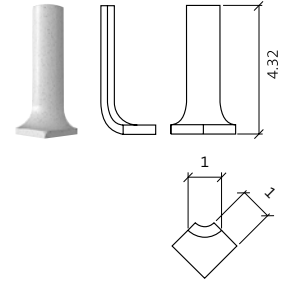

**U 4" x 1"**  
outside angle

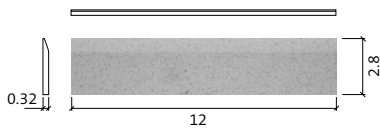

**BN 12" x 2.8"**  
bullnose skirting

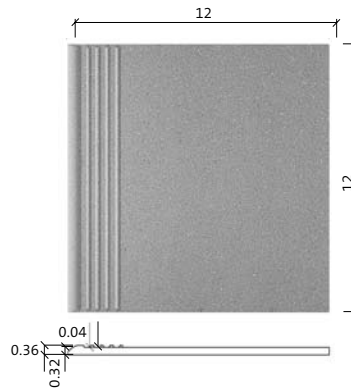

**T 12" x 12"**  
stair-tread (rounded edge)

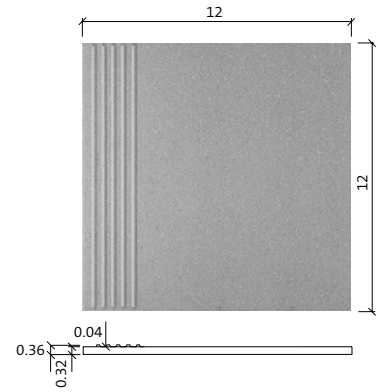

**TR 12" x 12"**  
stair-tread (straight edge)

T (rounded edge) stair-treads are discontinued, but will remain available as long as stock lasts.  
TR (straight edge) stair-treads will replace T stair-treads gradually.

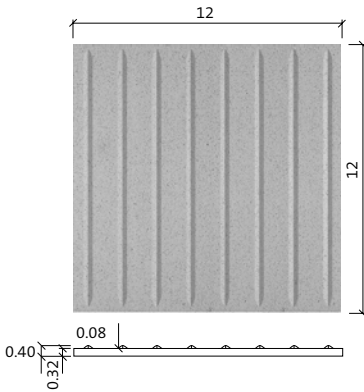

**BG 12" x 12"**  
guide tile

Special guide tiles for the blind (Global Collection BG) are to be supplied on request as floor marking strips for the visually disabled.

Like any material, Royal Mosa's ceramic tile can become slippery when wet. Care should be taken to keep the surface dry at all times. Our tiles should be installed in accordance with the current application guides of the Tile Council of America and/or American National Standards Institute guides and standards. Errors and omissions excepted.

This technical product sheet replaces all previous versions. For the most actual version see [www.mosa.nl](http://www.mosa.nl).



**Royal Mosa**  
Meerssenerweg 358  
P.O. Box 1026  
NL-6201 BA Maastricht  
T +31 (0)43 368 92 29  
F +31 (0)43 368 93 56  
[usa@mosa.nl](mailto:usa@mosa.nl)  
[www.mosa.nl](http://www.mosa.nl)



Mosa Tiles have been certified Silver by MBDC/EPEA, for their material content, recyclability and manufacturing characteristics.